

IEEE SA における標準化

IEEE P3800 Chair/ex 802.11ai Chair 眞野 浩

AGENDA

IEEE-SAにおける標準化

IEEE P802.11
標準化の事例

IEEE P3800の事例

標準化の成功とは



標準化の成功とは、市場形成をリードし**ブルーオーシャン**を作ること。



標準化の成功者は、市場成長モデルを示し、世界の流れを作るリーダーというプレゼンスを得る。



ICT技術の**C**ommunication は、Proprietary では成立しない。
使われる標準=つながる標準=つながる相手がある標準



市場をつくり市場をリードすることで、日本の経済成長を牽引することこそが、技術の基盤を強化する。

標準化は、新しい市場を喚起する

• 競争社会 → 協創社会

各社は、独自の市場を開発

標準化による協業社会

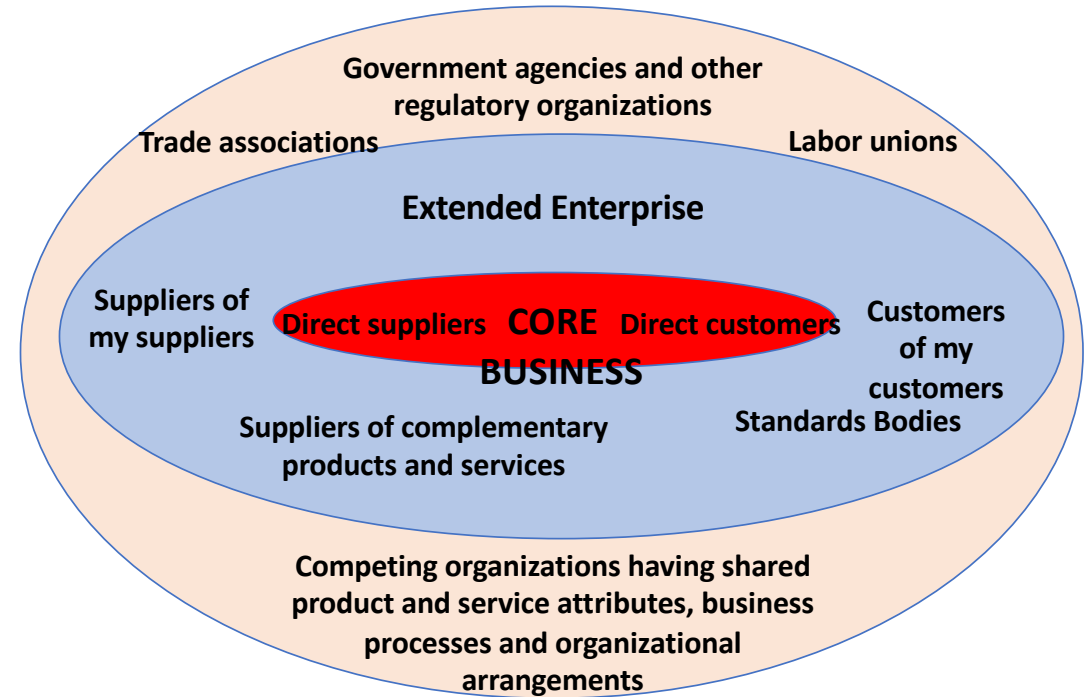
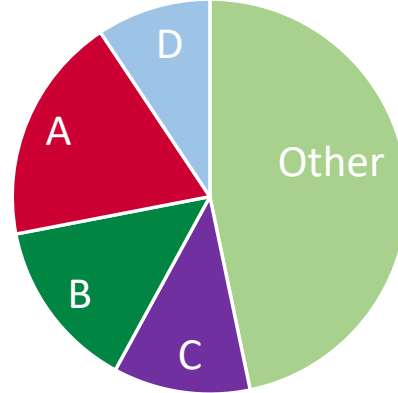

Moore, James F. (1996). *The Death of Competition: Leadership & Strategy in the Age of Business Ecosystems*.

802.11デバイスの成長事例

IEEE-SA & DTA セミナ資料から

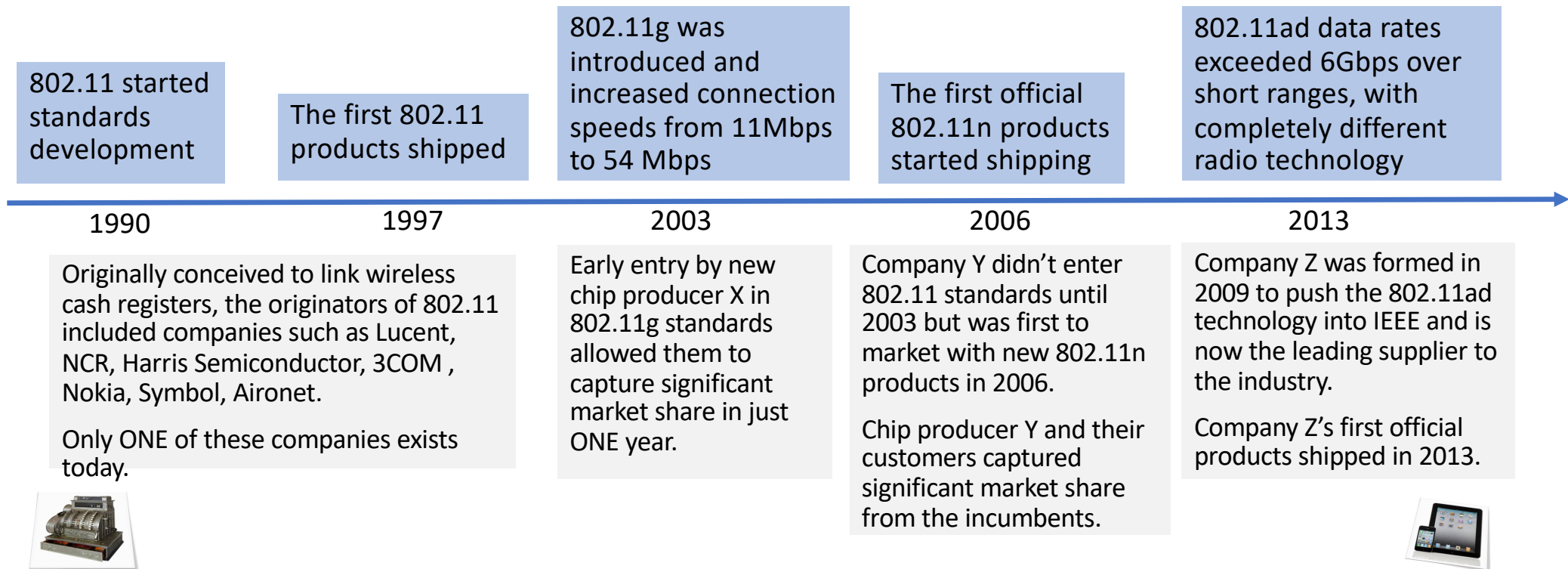

IEEE-SAにおける 標準化の基礎

IEEE-SAの仕組みとルール

IEEEについて

<https://standards.ieee.org/about/sasb/index.html>

■世界最大クラスのSDO

- Globally recognized standards
- 1256 active standards
- 718 standards under development
- 7264 individual members and approximately 20,000 standards developers from every continent
- 280 corporate members

■IEEE規格の強みと影響力

- Leverages the breadth of 40+ technical areas
- 100+ Smart Grid standards
- Flagship transport layer standards in communications (IEEE 802)
- 400-500 standards focused on the power and energy sector, etc.
- Independent global community
- Open standards development process
- IEEE-SA Strengths

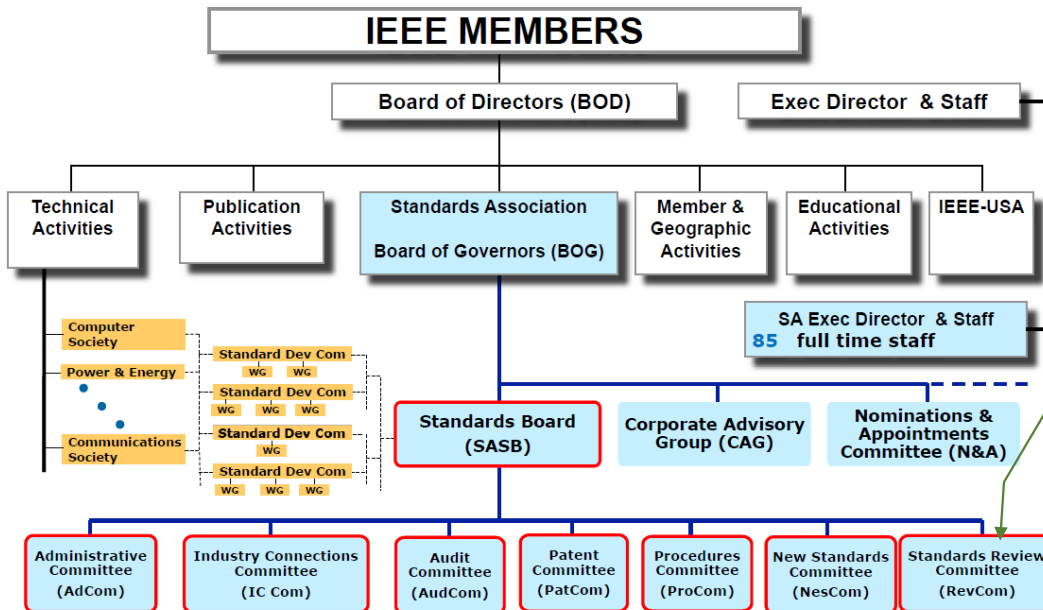

標準化活動はIEEE-SAの下におけるSASB(Standard Board)の指揮下で行っている。

標準承認：新規標準委員会 (NesCom)、標準レビュー委員会 (RevCom)
 進捗制御：手続き委員会 (ProCom)、特許委員会 (PatCom)、監査委員会 (AudCom)
 標準革新：業界連携委員会 (ICCom)
 管理監督：管理委員会 (AdCom)

IEEE-SAの概要(1/2)

- IEEE (Institute of Electrical and Electronics Engineers)は、アメリカ合衆国に本部を置く電気・情報工学分野の学術研究団体（学会）であり、SA(Standard Association)は、この IEEE配下の標準化を担う機関である。
- この母体であるIEEEは、160か国以上で422,000人以上の会員を有しているが、その50%以上が米国以外の国と地域に属している。
- 標準化は下図に示すように、開発過程から社会実装展開へと移行する段階の活動として捉えている。

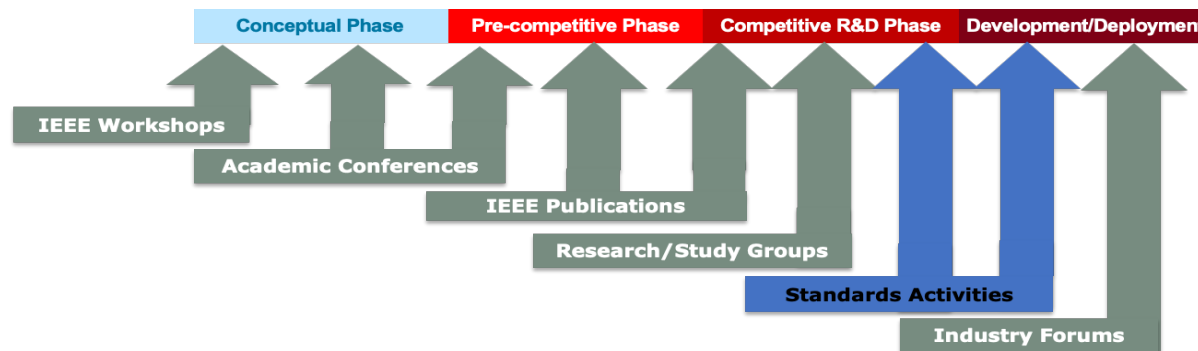

IEEEの活動のタイムライン (2018/03/05 IEEE-SA共催データ流通と標準化シンポジウム配布資料より)

IEEE-SAの概要(2/2)

• ビジョン&ミッション

- ビジョン：世界クラスの標準開発組織になること。
- ミッション：世界的に尊敬される、高品質で市場に関連する標準化環境を提供する。

• 実績

- 累計20,000を超える国際標準仕様の開発実績。
- 内1,200を超える標準仕様は、現時点でも有効に160カ国以上で批准されている。また、600を超える標準仕様の策定が現在進行中。



IEEE-SAの現状と活動範囲

<https://mentor.ieee.org/802-ec/dcn/19/ec-19-0098-00-00EC-ieee-802-orientation-2019.pdf#search=http%3A%2F%2Fiee802.org+ec1900980000EC>

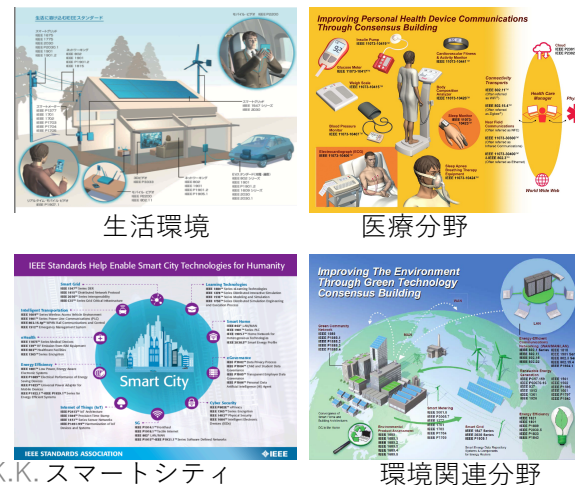

SASB(Standards Board) (1/2)

定義及び役割

- IEEE-SAにおける標準策定に関する最高意思決定機関。BOGによって設立および任命される。
- IEEE規格の開発と改訂の奨励および調整を行う。

構成員

- SASBは18人から26人の投票メンバーで構成される。
- 構成員はすべてIEEEかつIEEE SAメンバーである、
- 各スポンサーソサエティを管轄するIEEE Technical Activities Board Liaisonも投票メンバー。投票権のない名誉会員が1人含まれる。

2020 Roster 名簿

Gary Hoffman (Chair)	Jon Rosdahl (Vice Chair)	John Kulick (Past Chair)	Konstantinos Karachalios (Secretary, non-voting)
----------------------	--------------------------	--------------------------	--

Members メンバー

Ted Burse	Paul Nikolich [TAB Rep.]	David Law	Sha Wei
Doug Edwards	Damir Novosel	Howard Li	Philip Winston
Travis Griffith	Dorothy Stanley	Dong Liu	Daidi Zhong
Grace Gu	Mehmet Ulema	Kevin Lu	Jingyi Zhou
Guido Hiertz	Lei Wang		

Member Emeritus

名誉会員 Joseph Koepfinger (non-voting)

IEEE Government Engagement Program on Standards (GEPS) Representatives

各国の政府関連プログラム代表 (省略)

Administrator

Hiroshi Muraoka 管理者 K Dave Ringle

<https://standards.ieee.org/about/bog/index.html>

SASB(Standards Board) (2/2)

構成される委員会とその役割

①AudCom (Audit Committee)

- 標準開発を行う機関(ワーキンググループや委員会)に対する監査機関。

②IC Com (Industry Connections Committee)

- 産業界との連携活動の開始を求めるICAID (Industry Connections Activity Initiation Documents) を調査し、その承認に関してIEEE SASBに勧告する委員会。

③NesCom (New Standard Committee)

- 提案された標準プロジェクトが適切なソサエティまたは他の組織に割り当てられたIEEEの範囲と目的の範囲内にあり、複数の団体がIEEE標準の開発に適切に参加していることを確認する責任を持つ委員会。

④PatCom (Patent Committee)

- IEEE規格の特許および特許情報の使用を監視する委員会。

⑤ProCom (Procedure Committee)

- SASBおよび標準化活動に従事する他のIEEE委員会による責任の効率的な遂行を促進するために、SASBの改善と手順の変更を推奨する責任を持つ委員会。

⑥RevCom (Standard Review Committee)

- IEEE SASBの承認または採択のために提出された規格の承認または不承認に関する勧告を行う委員会。

IEEE標準化の基本

運営

- WTO (World Trade Organization)/ TBT(Agreement on Technical Barriers to Trade)の原則に準拠すること。
- 厳格なピアレビューが行われること。
- 参加者の集合的なコンセンサスの見解を反映していること。
- 高品質でグローバルに関連する技術標準になること。

基本ポリシー

①Consensus 合意性

- 参加者の多数による合意がされていること。

②Due Process 適正な策定手順

- 全てにおいて適正な手順が取られていること。

③Openness オープン性

- 誰でもが、開発に参加する機会が与えられること。

④Right of appeal 異議申立ての権利

- 誰もが、規格の策定前、策定後でも意義を申し立てる権利があること。

⑤Balance バランス

- すべての重要な利害関係者メンバーからの意見が反映されていること。

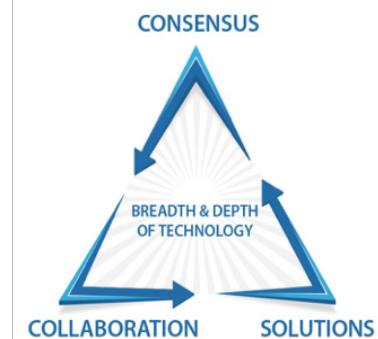
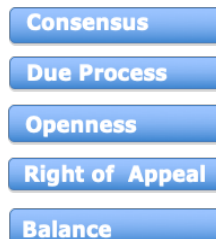

Robert's Rules of Order

- ロバートの会議規則とは、
 - 1876年にアメリカ陸軍のヘンリー・ロバート将軍が作成。
- 会議規則が守るもの
 - (1) 多数者の権利（過半数の賛成）
 - (2) 少数者の権利（少数意見の尊重）
 - (3) 個人の権利（プライバシーの権利擁護）
 - (4) 不在者の権利（不在投票）
- 例えば
 - 発言者は、議長とのみ話せる
 - ローカルトークの禁止
 - 動議提案
 - 2人以上の賛同が必要
 - 審議棚上げ
 - 不十分な動議は、棚上げされる
 - 会期満了で失効
 - 一事不再議
 - 一度議決されたものは、審議できない

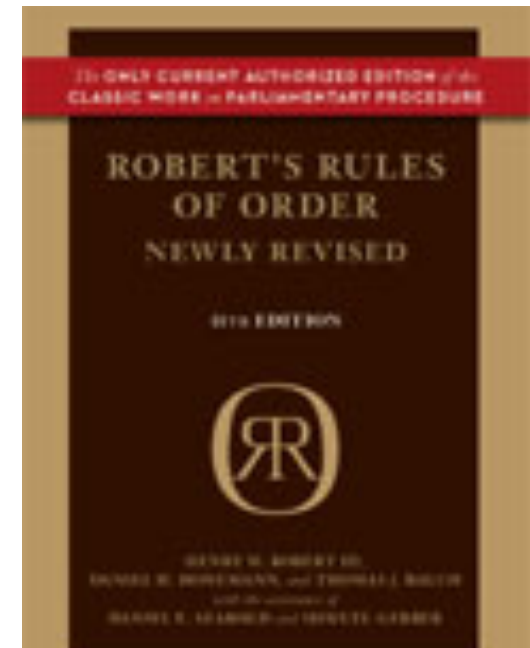

IEEE-SAにおける標準作成の流れ

標準化手順



策定期間及び有効期限

- 策定はプロジェクト開始から4年以内
- 公開された標準は修正や改定がなければ10年で無効となる

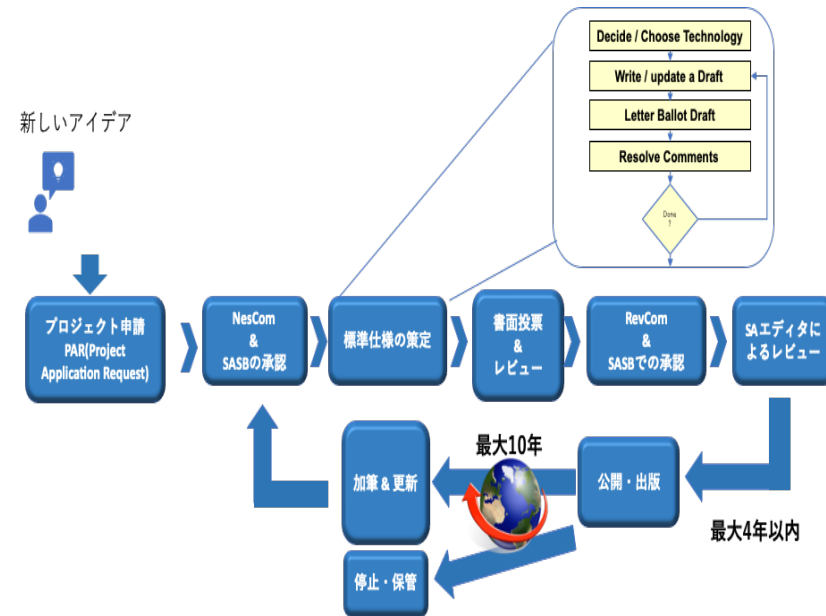

IEEEにおける標準化手順

新しいアイデア

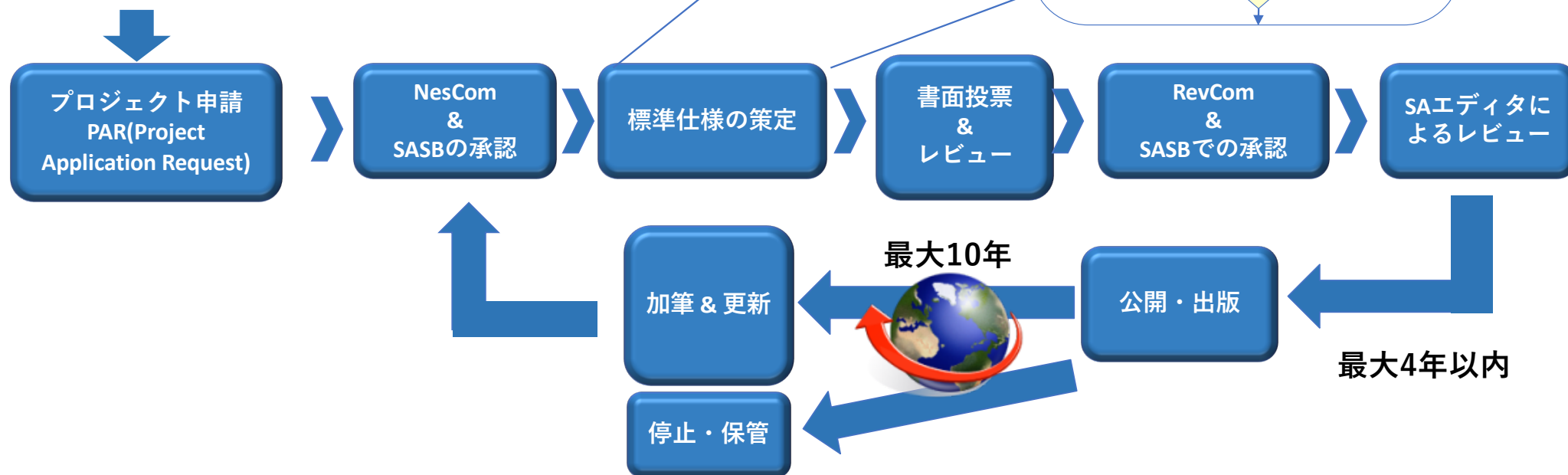

https://jp.ieee.org/activities/files/About_IEEE-SA_July2015.pdf

IEEEの標準化手順 2

個人標準化プログラム(Individual method) IEEE802等

- 参加単位は、個人
- 個人は、あくまで個人の利益代表
- 各個人は、1投票権を有する
 - 最低10人の投票権者による投票参加が必要
- 投票権者は、IEEE-SA 個人会員であること (WGへの参加やWGの投票は、非会員でも可能)

法人標準化プログラム(Entity method) IEEE P2413等

- 参加単位は、“entities=機関,” 例えば, 法人, 大学, 政府機関, など
- 参加者は、機関に指定された代表者または代理人。
- 各機関は、1投票権を有する
 - 最低3機関による投票参加が必要
- 各機関は、その利益代表者が会議に参加し投票権を行使する

The [IEEE-SA Standards Board Bylaws](#) require that “participants in the IEEE standards development individual process shall act based on their qualifications and experience”

This means participants:

- Shall act & vote** based on their personal & independent opinions derived from their expertise, knowledge, and qualifications
- Shall not act or vote** based on any obligation to or any direction from any other person or organization, including an employer or client, regardless of any external commitments, agreements, contracts, or orders
- Shall not direct** the actions or votes of other participants or retaliate against other participants for fulfilling their responsibility to act & vote based on their personal & independently developed opinions

By participating in standards activities using the “*individual process*”, you are deemed to accept these requirements; if you are unable to satisfy these requirements then you shall immediately cease any participation

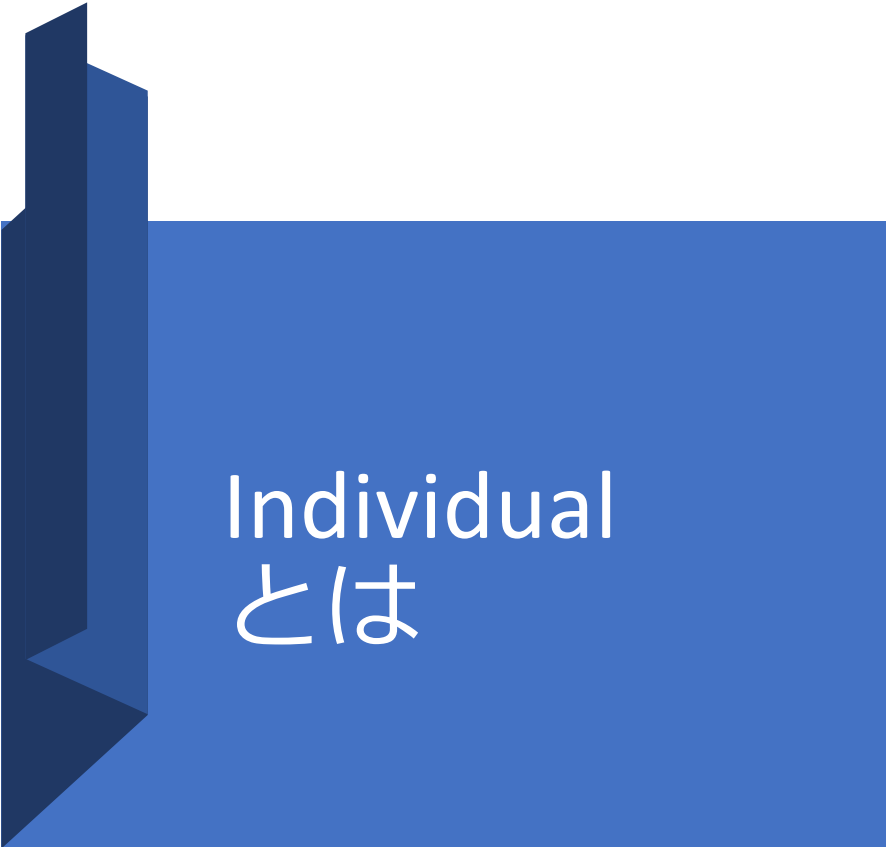

Individual
とは

IEEE SAの 標準必須特許

- FRAND: Fair, Reasonable And Non-Discriminatory (公平、妥当かつ差別のないライセンス)
 - 標準必須特許は、その標準を使用する者にたいして公平、妥当かつ差別がなく使用許諾をする。
 - ただし、その許諾条件は、当事者間の調整であり、無性提供を求めるものではない。
- *If anyone in this meeting is personally aware of the holder of any patent claims that are potentially essential to implementation of the proposed standard(s) under consideration by this group and that are not already the subject of an Accepted Letter of Assurance, please respond at this time by providing relevant information to the WG Chair.*
- この会議に参加している誰かが、このグループが検討している提案規格の実施に不可欠となる可能性のある特許請求項の保有者を個人的に知っている場合で、まだ承認されたLoAの対象となっていない場合は、この時点でWG議長に関連情報を提供することで対応してください。

IEEE Standardの種類

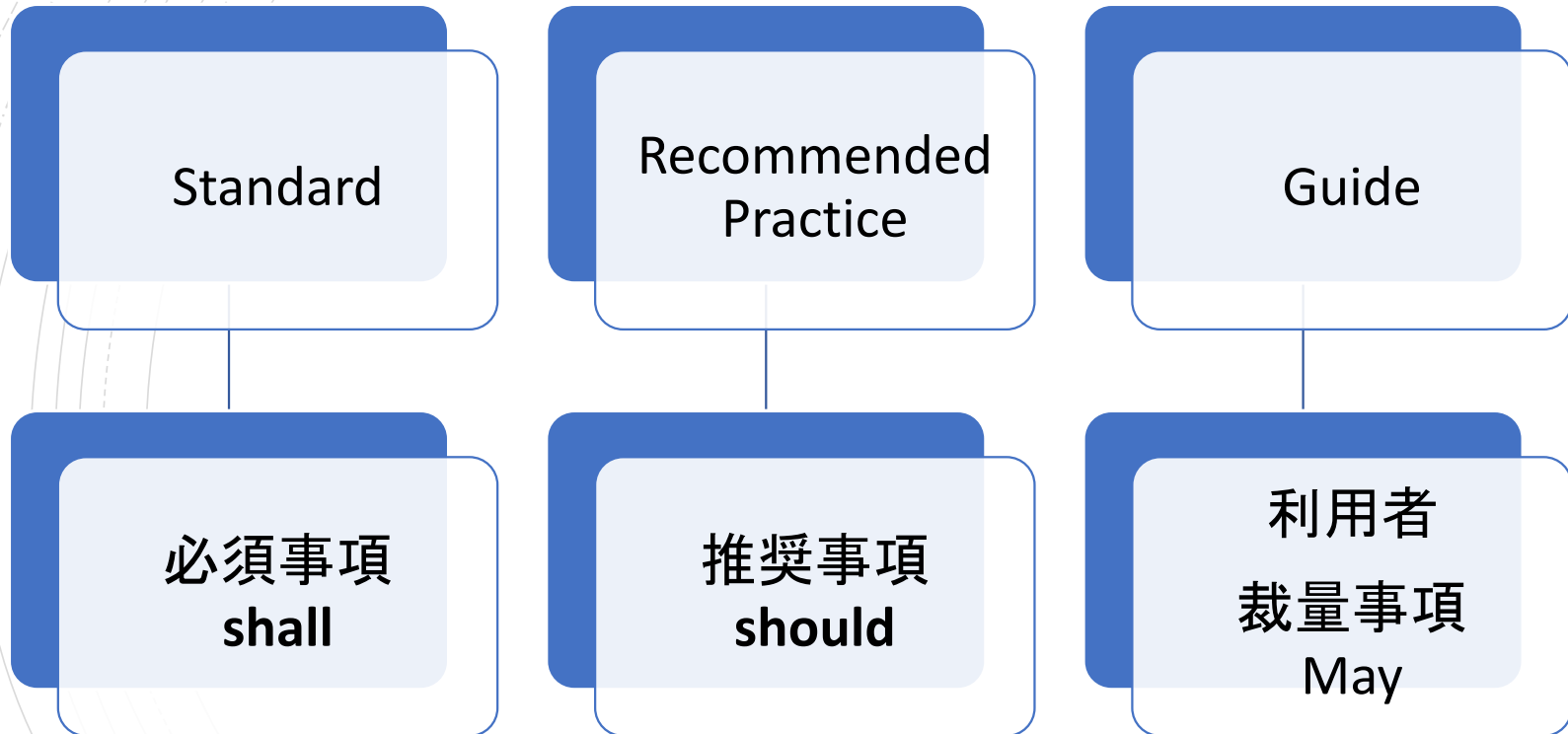



IEEE Standardの 記載手法

2020/09/15

Hiroshi Mano / Koden-TI.K.K.

Normative

- Information that is required in order to implement the standard
- The text that establishes requirements, recommendations, or alternative approach.
- 規格を実施するために必要な情報
- 要件、推奨事項、または代替的なアプローチを定めた文章

Informative

- Informative text is provided for background only and is therefore not officially part of the standard.
- Text that puts the processes and procedures in context, illustrates them, explains them
- 情報提供、背景説明だけに提供されており、正式な規格の一部ではない。
- プロセス及び手順を文脈に沿って説明し、図示し、説明する文章など

IEEE P802.11標準化事例

802 LMSC

802.11 WLAN

Reference
Model for
End Stations

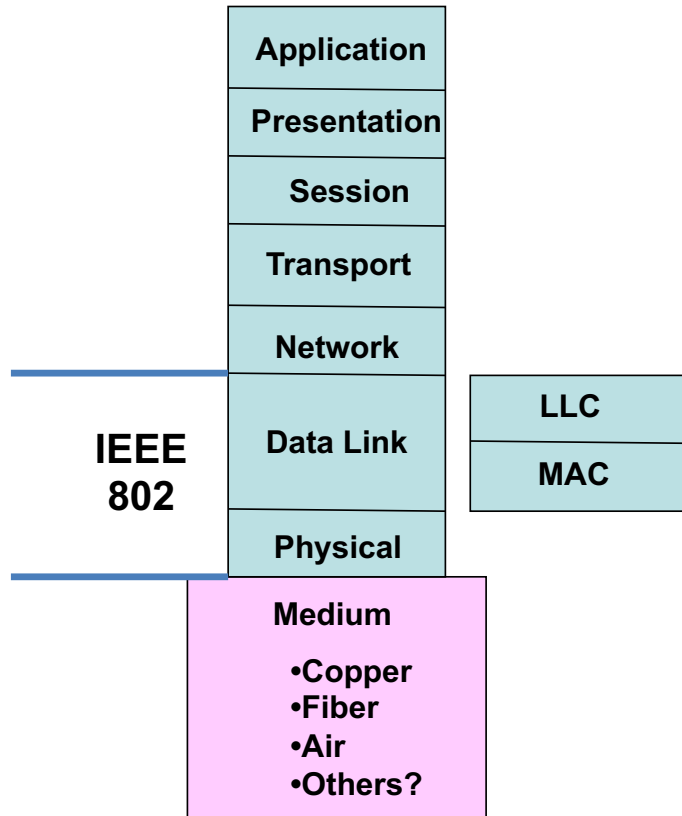

July 2020/ doc.: IEEE 802.11-20/0007r2

2020/09/15

IEEE802の対象範囲

- IEEE 802 standards emphasize the functionality of the lowest two layers of the OSI reference model, and the higher layers as they relate to network management
 - physical layer (PHY, Layer 1)
 - data link layer (DLL, Layer 2)
- IEEE 802 divides DLL into:
 - Medium Access Control (MAC)
 - Multiple specifications
 - Common logical link control (LLC)
- See details in IEEE Std 802
 - “IEEE Standard for Local and Metropolitan Area Networks: Overview and Architecture”

Hiroshi Mano / Koden-TI.K.K.

IEEE802 LMSC と802.11WG

IEEE 802 within IEEE and IEEE-SA Structure

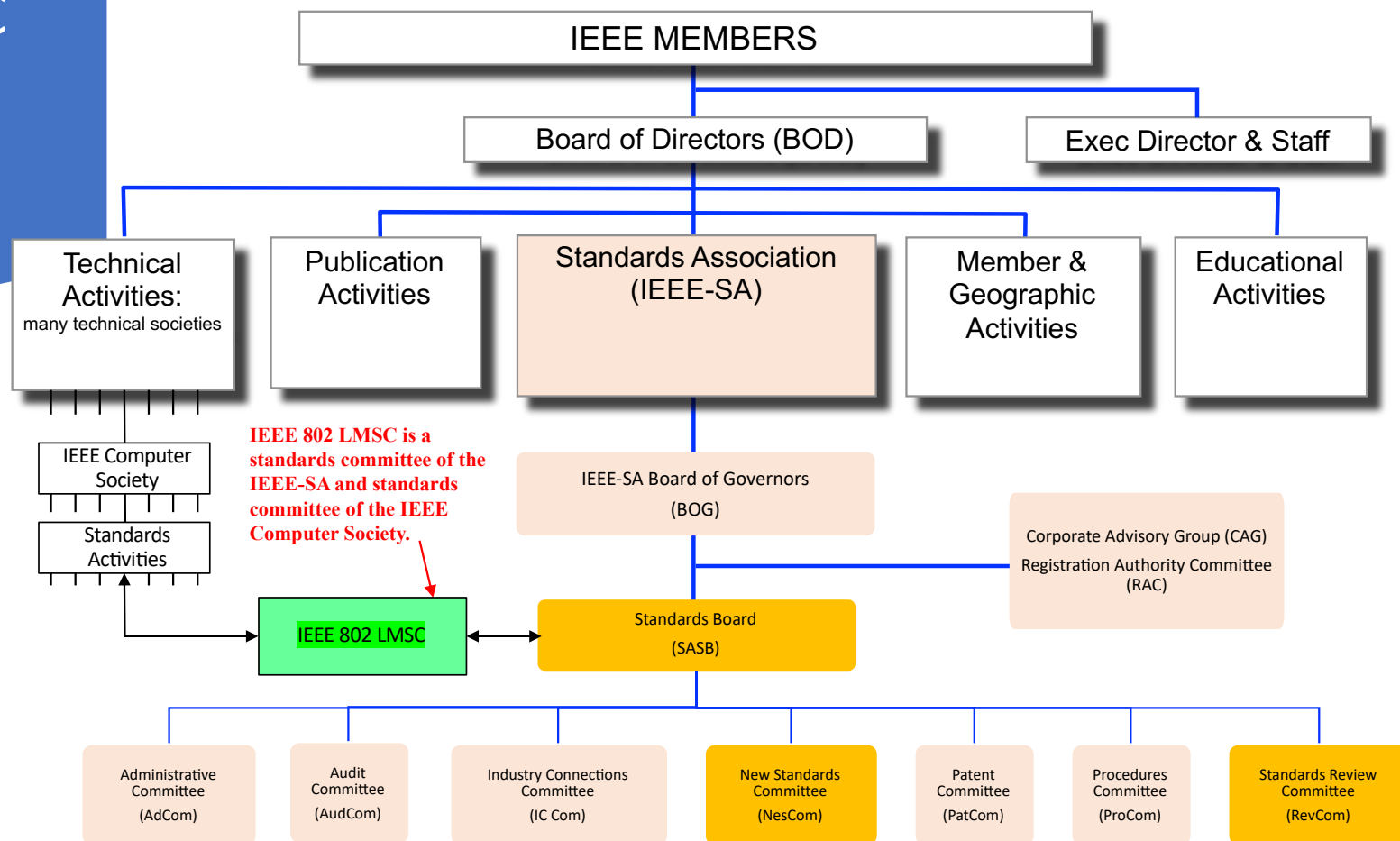

IEEE802 LMSC ECの構成

IEEE 802 EXECUTIVE COMMITTEE (EC)

CHAIR
Paul Nikolich

Working Group/TAG Chairs

802.1 Bridging/Arch Glenn Parsons	802.3 Ethernet David Law	802.11 WLAN Dorothy Stanley
802.15 WPAN Bob Heile	802.18 TAG Radio Regulatory Ray Holcomb	
802.19 Coexistence Steve Shellhammer	802.24 Vertical Applications Tim Godfrey	

Appointed Officers

1st Vice Chair James P.K. Gilb	2nd Vice Chair Roger Marks
Executive Secretary Jon Rosdahl	Recording Secretary John D'Ambrosia
Treasurer George Zimmerman	Member Emeritus (non-voting) Clint Chaplin
	Member Emeritus (non-voting) Geoff Thompson

Hibernating WG Chairs (non voting)

802.17 Resilent Packet Ring John Lemon	802.21 Media Indep. Handover Servs Subir Das
802.16 BWA Roger Marks	802.22 WRAN Apurva Mody

HIBERNATED

802.16 Broadband Wireless Access
802.21 Media Independent Hanover Services
802.22 Wireless Regional Area Networks

DISBANDED

802.2 Logical Link Control
802.6 Distributed Queue Dual Bus
802.9 Integrated Service LAN
802.10 Security
802.14 Cable Modems
802.20 Mobile Broadband Wireless Access

802.4 Token Bus
802.5 Token Ring
802.7 Broadband TAG
802.8 Fiber Optic TAG
802.12 Demand Priority
802.23 Emergency Services

July 2020/ doc.: IEEE 802.11-20/0007r2

Participant 参加できるのは?

- For the development of standards, **openness** and **due process** are mandatory.
- Openness requires that any person who has, or could be reasonably expected to have an interest, and who meets the requirements of these procedures, has a right to participate by:
 - a) Attending Working Group meetings (in person or electronically)
 - b) Becoming a member of the Working Group
 - c) Becoming an officer of the Working Group
 - d) Expressing a position and its basis,
 - e) Having that position considered, and
 - f) Appealing if adversely affected.
- IEEE やIEEE SA の会員でなくても参加できます。

Working Group Responsibilities WGの役目

- a) Complete the project from Project Authorization Request (PAR) approval to IEEE-SA Standards Board approval as specified by the PAR, and in compliance with IEEE-SA policies and procedures.
- b) Use the IEEE-SA document template format.
- c) Submit to the Sponsor any documentation required by the Sponsor; e.g., a project schedule or a monthly status report.
- d) Notify the Sponsor of the draft development milestones.
- e) Notify the Sponsor when the draft is ready to begin IEEE-SA Sponsor ballot.
- f) Only those authorized to access and use IEEE's data, including personal data, from IEEE systems are permitted to do so, for the purposes intended, including to support the technical development work on the standard, and only in compliance with IEEE or IEEE- SA Privacy and data privacy policies.

Participant

参加者の種類

会議に参加することで、WGのメンバーになれる。

Non-Participant

Participant

Non-member

Member

Non-Voting Member

Voting Member

一定数参加することで、投票権が得られる。

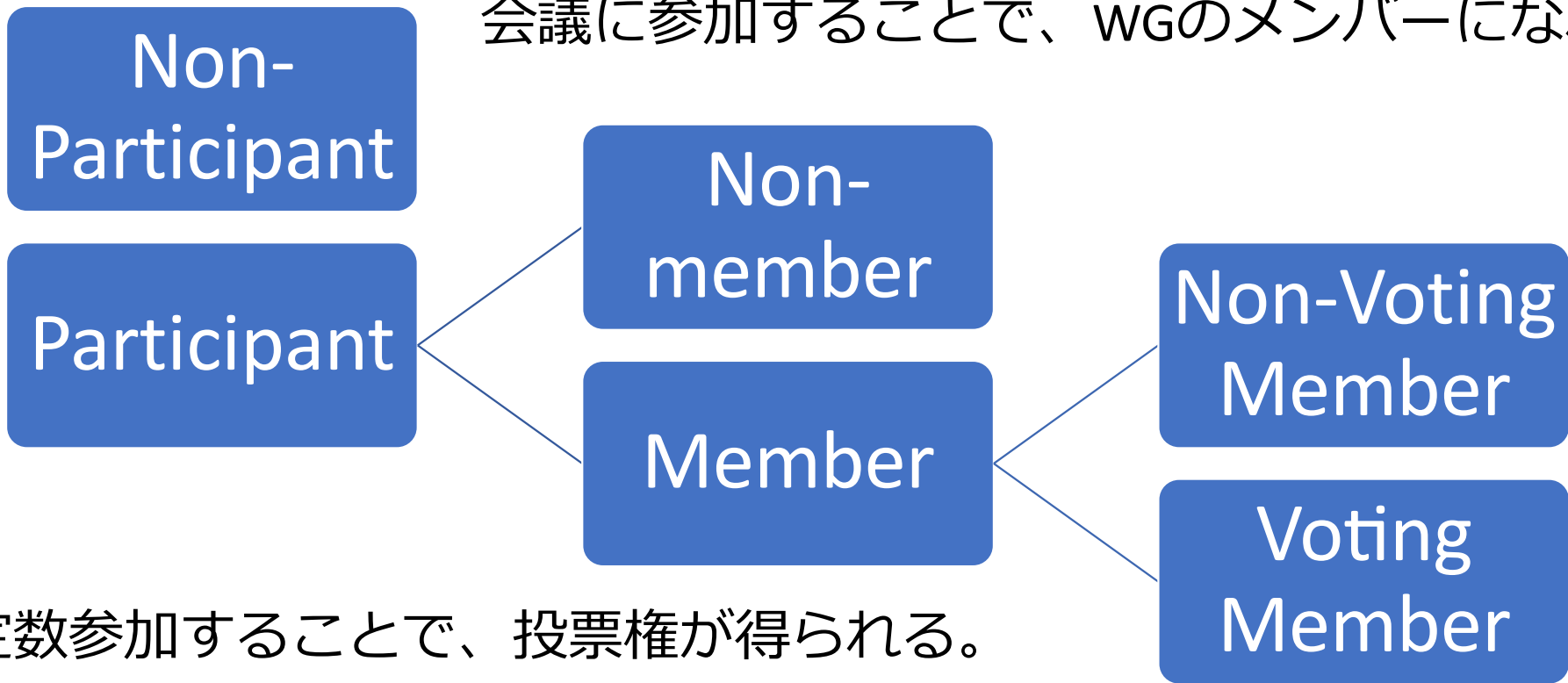

地域別参加者

Members by country and region

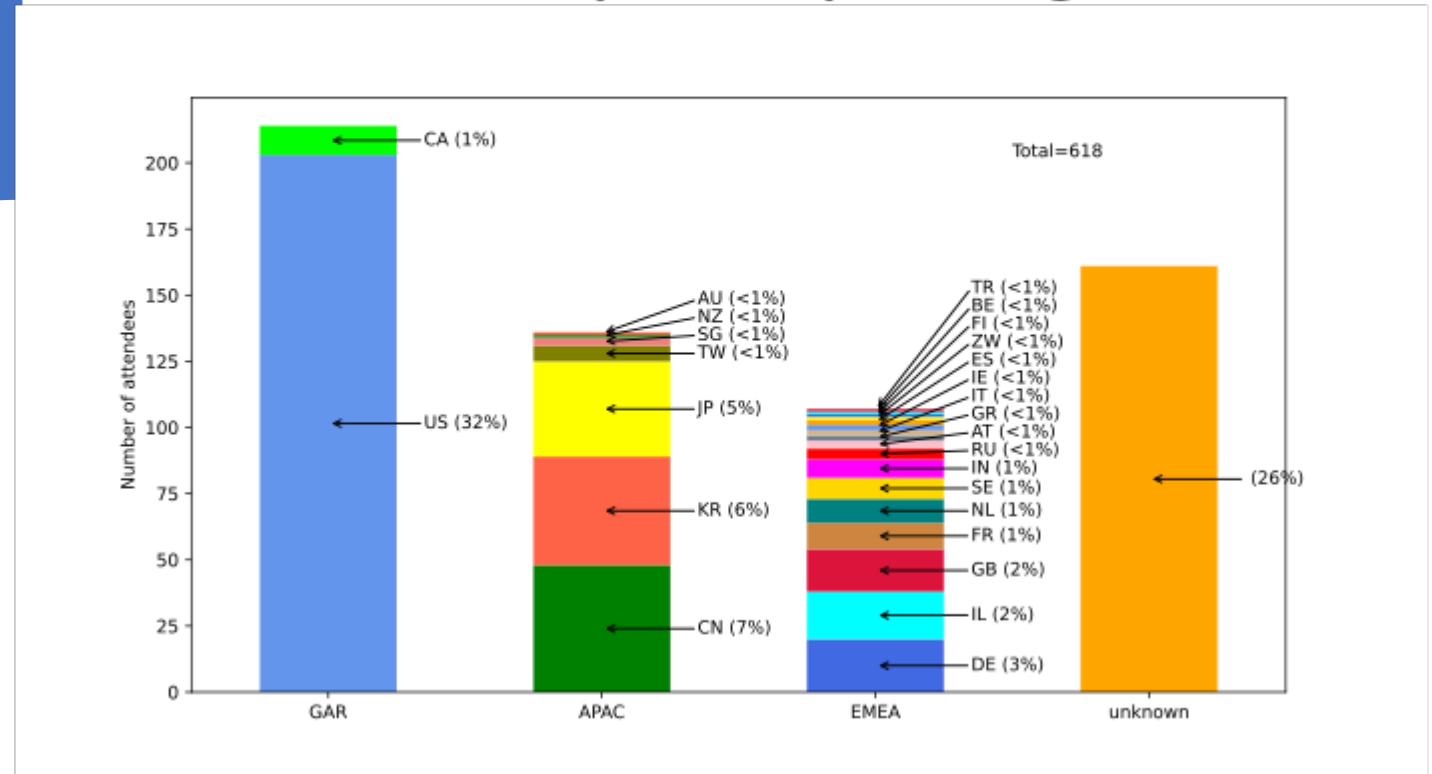

Affiliation

Attendees by affiliation (attended at least one meeting Nov to Jan)

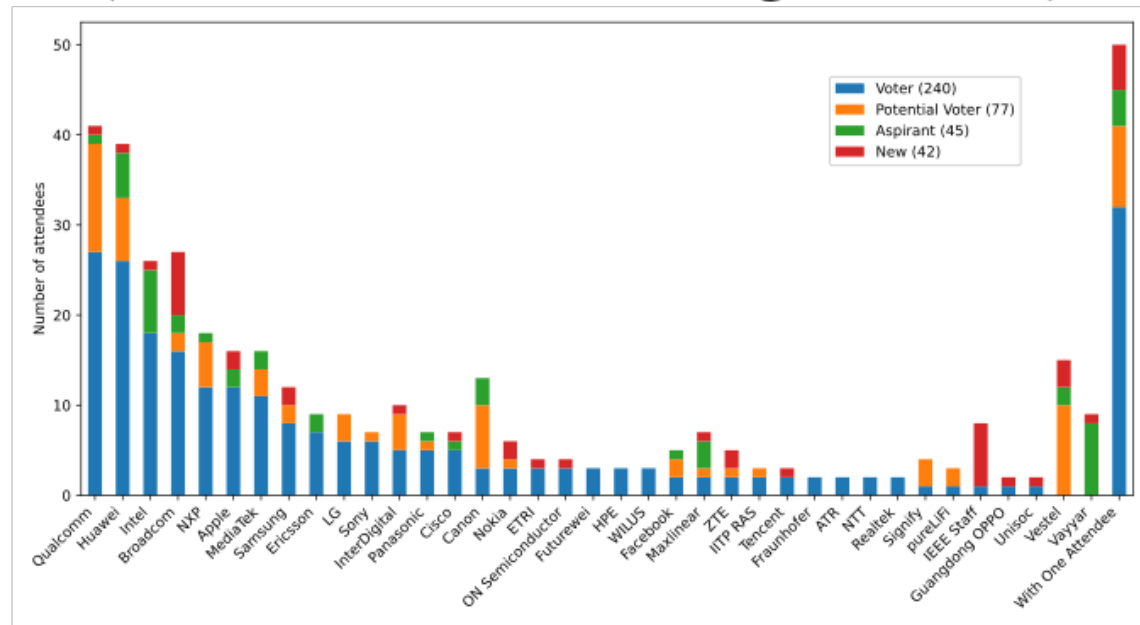

IEEE802 の投票権

- 意思決定は、多数決で決めるため投票権が必要
- 投票権取得条件
 - 投票権は 4 回の連続する Plenary のうち 3 回目の出席で取得
 - 3 回のうち 1 回は Interim で代替可
 - 投票権付与は Plenary のみ
 - セッションの 75% 以上出席しないと出席とは認められない
 - Base Slot が 18 コマだと 14 コマ以上出席
- 投票権維持
 - 直近4回の Plenary 中2回 (1回は, Interim でも可能) に出席が必要.
 - 書面投票による投票権の行使が義務

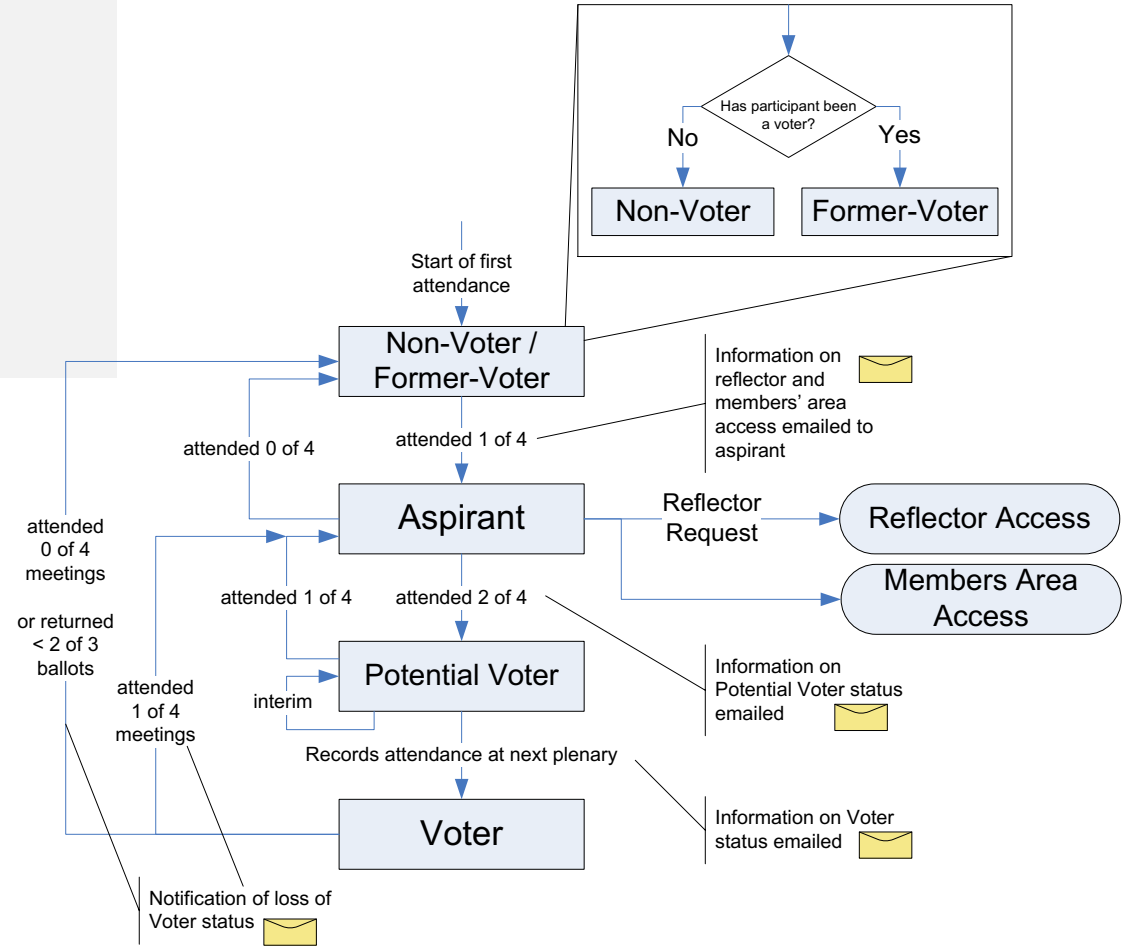
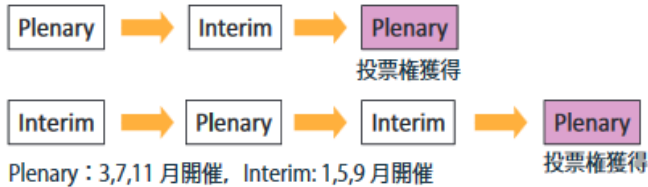

IEEE802 WGの 標準化手順

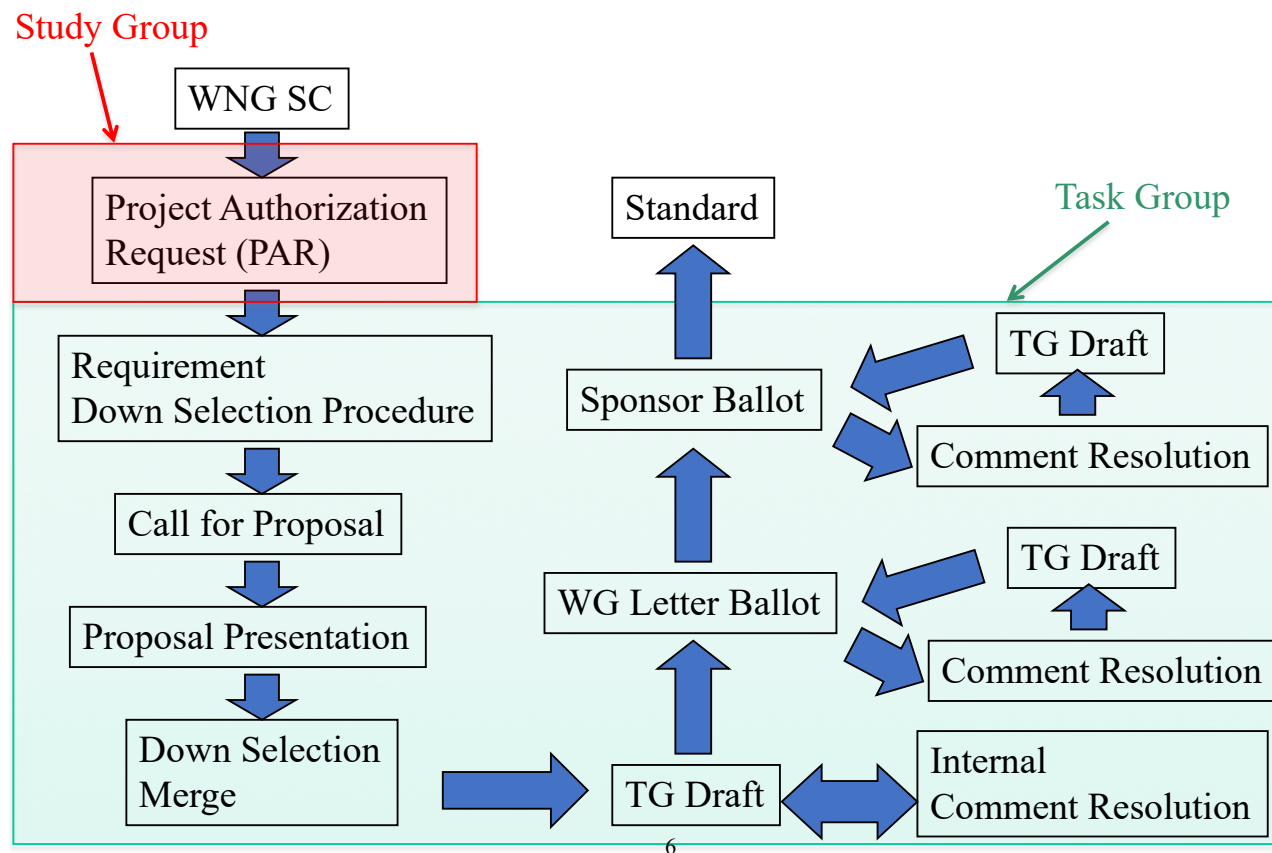

IEEE 802.11 Revisions

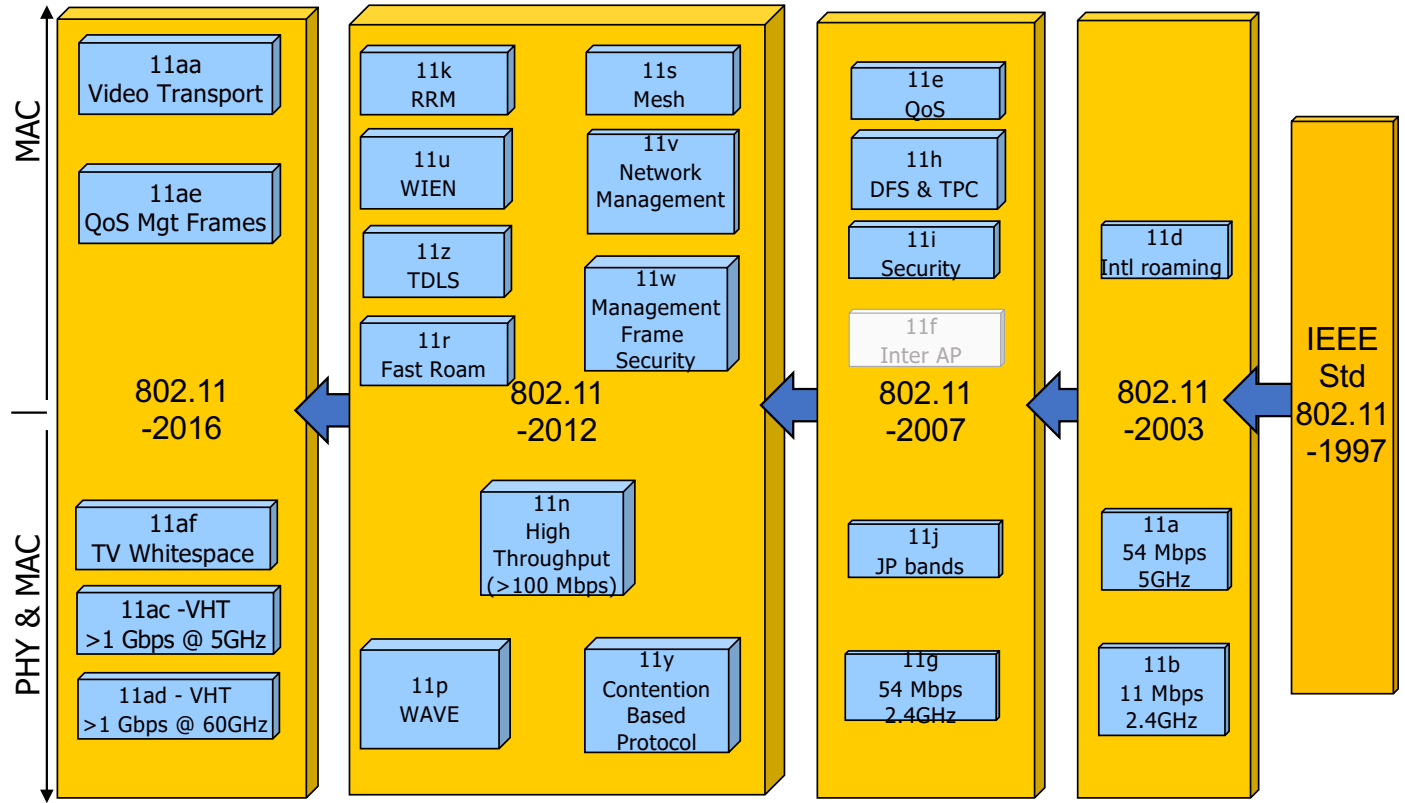

Jan 20201/ doc.: IEEE 802.11-20/1905r1

IEEE 802.11 Standards Pipeline

M4.1.4 IEEE 802.11 Standards Pipeline

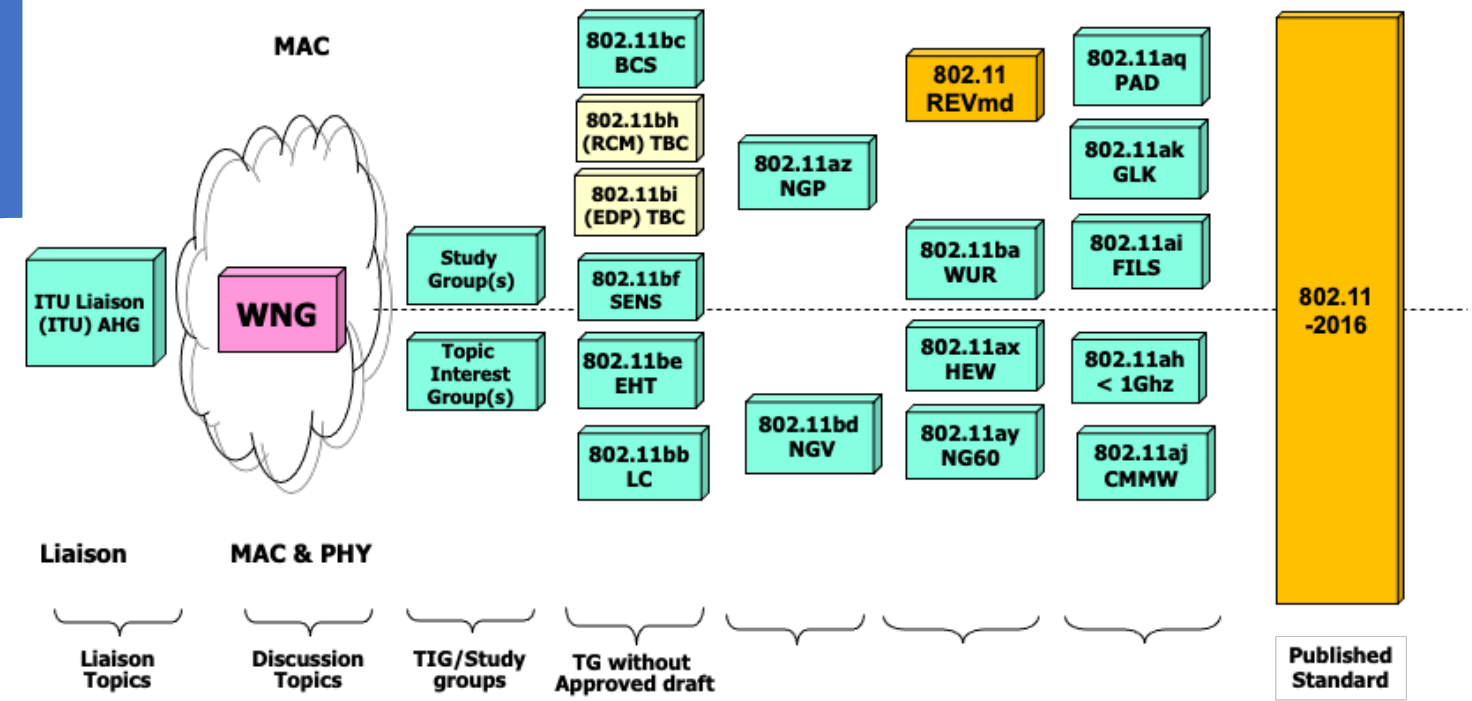

July 2021/ doc.: IEEE 802.11-20/1905r1

DTSI (Data Trading System Initiative)の事例

2019-Jun ~ 2020-Apr



Introduction of DTSI ICAID

IC19-0006-01 approved by the IEEE-SASB 11 June 2019.

- Motivation and goal
- The next large-scale transformation, leading to a human-centric society based on a system that highly integrates cyberspace and physical space has been termed Society 5.0 in Japan. Data sharing, augmented by algorithmic decision making/artificial intelligence and information technology, is a foundational building block to realizing this vision.
- A data-intensive sharing model, in which data is gathered by particular entities and provided to other parties, has to address many issues such as privacy protection and avoidance of undesirable business practices. In addition, data generation, which is growing rapidly through the spread of IoT devices, makes the need for efficient sharing more critical.
- Therefore, this activity proposes that the sharing of data should shift from a centralized system to an autonomous distributed sharing model. In this autonomous distributed sharing model, it is assumed that multiple different entities supply and receive data equitably from each other.
- To realize the benefits of data sharing, data flow from the data provider to the data receiver and compensation flow in the opposite direction shall occur, and that is defined as "Data Trading". Multiple entities can trade data directly or through a mediator in the "Data Trading" environment. To enable this environment, some standards will be required to maintain trusted data trading.
- In this activity, we propose drafting the PAR that will serve as the basis to form a new standards working group for a general standard for data trading scheme that is not dependent on the particular data type and protocol, and we expect to create related, more specific, standards proposals under that WG.
- サイバー空間と物理空間が高度に統合されたシステムを基盤とした人間中心の社会へとつながる次の大規模な変革が、日本では「Society 5.0」と呼ばれています。このビジョンを実現するための基盤となるのが、アルゴリズムによる意思決定・人工知能・情報技術によるデータ共有である。
- 特定の主体がデータを収集し、他の主体に提供するというデータ集約型の共有モデルでは、プライバシー保護や望ましくない商習慣の回避など、多くの問題に対処しなければならない。また、IoTデバイスの普及により急増するデータ生成は、効率的な共有の必要性をより重要なものになっている。
- そこで本活動では、データの共有を中央集権型から自律分散型の共有モデルに移行することを提案します。この自律分散共有モデルでは、複数の異なる主体が互いに公平にデータを供給・受信することを前提としています。
- データ共有のメリットを実現するためには、データ提供者からデータ受信者へのデータの流れと、その逆方向への補償の流れが発生することが必要であり、これを「データ取引」と定義する。「データ取引」環境では、複数のエンティティが直接または仲介者を介してデータを取引することができる。この環境を実現するためには、信頼されたデータ取引を維持するための規格が必要となる。
- 本活動では、特定のデータ型やプロトコルに依存しないデータ取引方式の一般的な標準化に向けて、新たな標準化ワーキンググループを形成するための基礎となるPARを起草することを提案し、その下で関連するより具体的な標準化提案を行うことを期待しています。

Hiroshi Mano (Data Society Alliance)



Existing Data Flow Architecture

- Data will be transferred from Data Provider to Data Consumer.
- No any rewards from Data Consumer to Data Provider

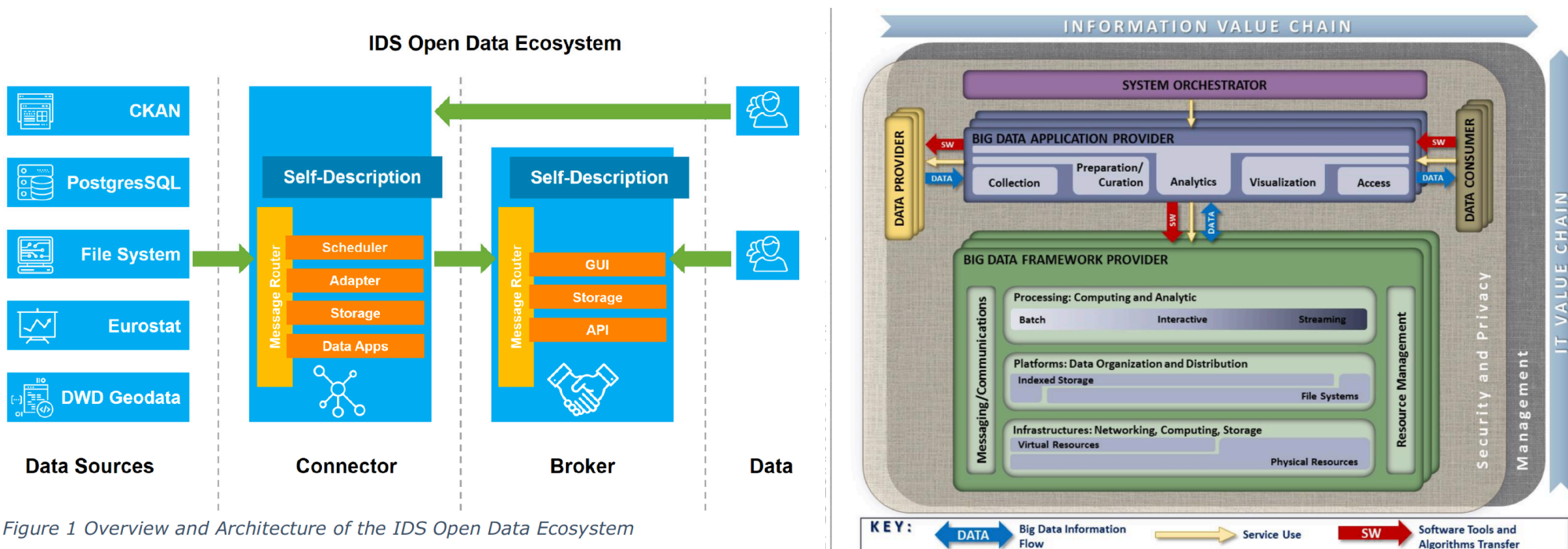
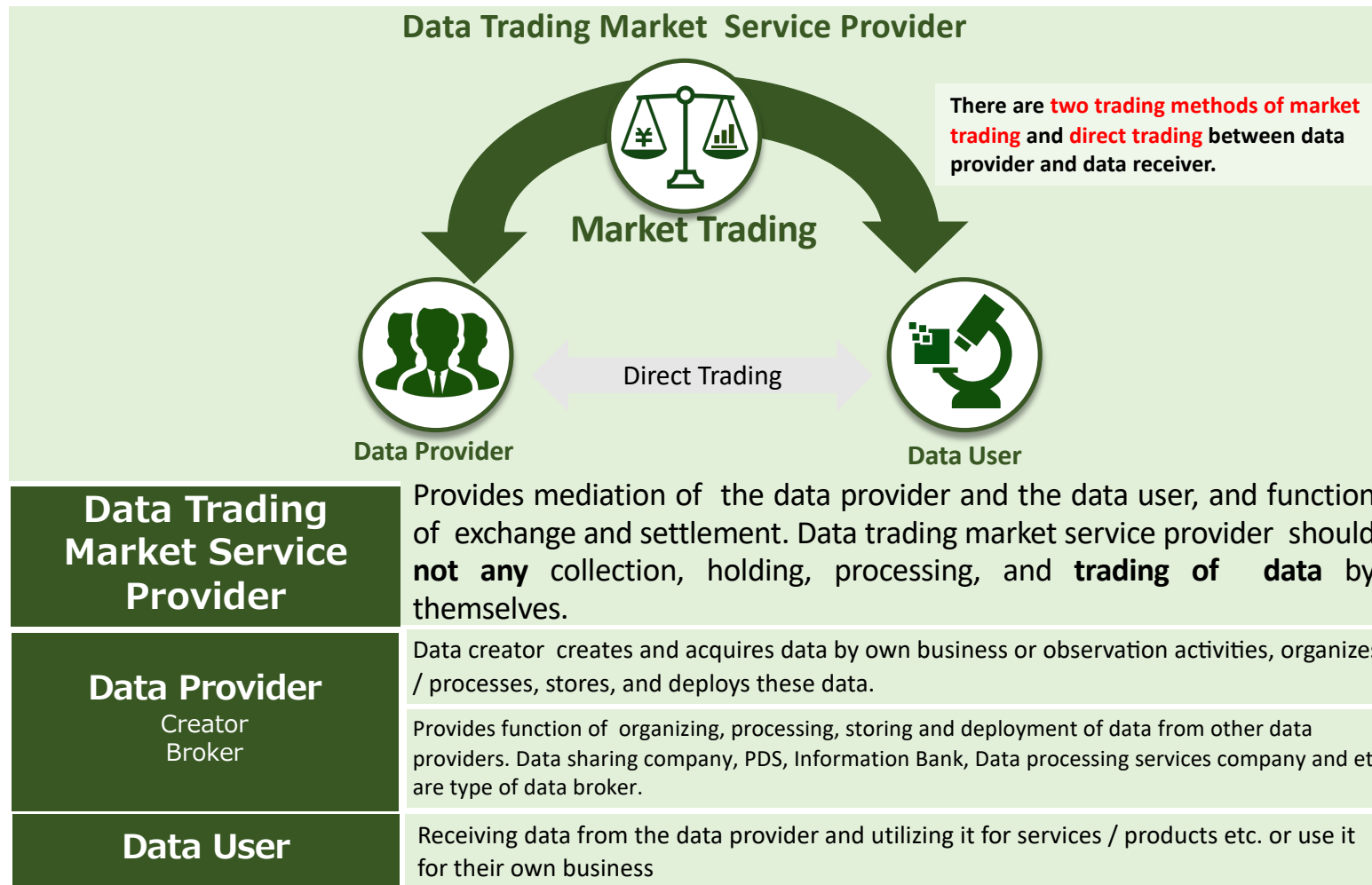

Figure 1 Overview and Architecture of the IDS Open Data Ecosystem

Data Trading Market & Players



Hiroshi Mano (Data Society Alliance)

Position of data trading market service provider.

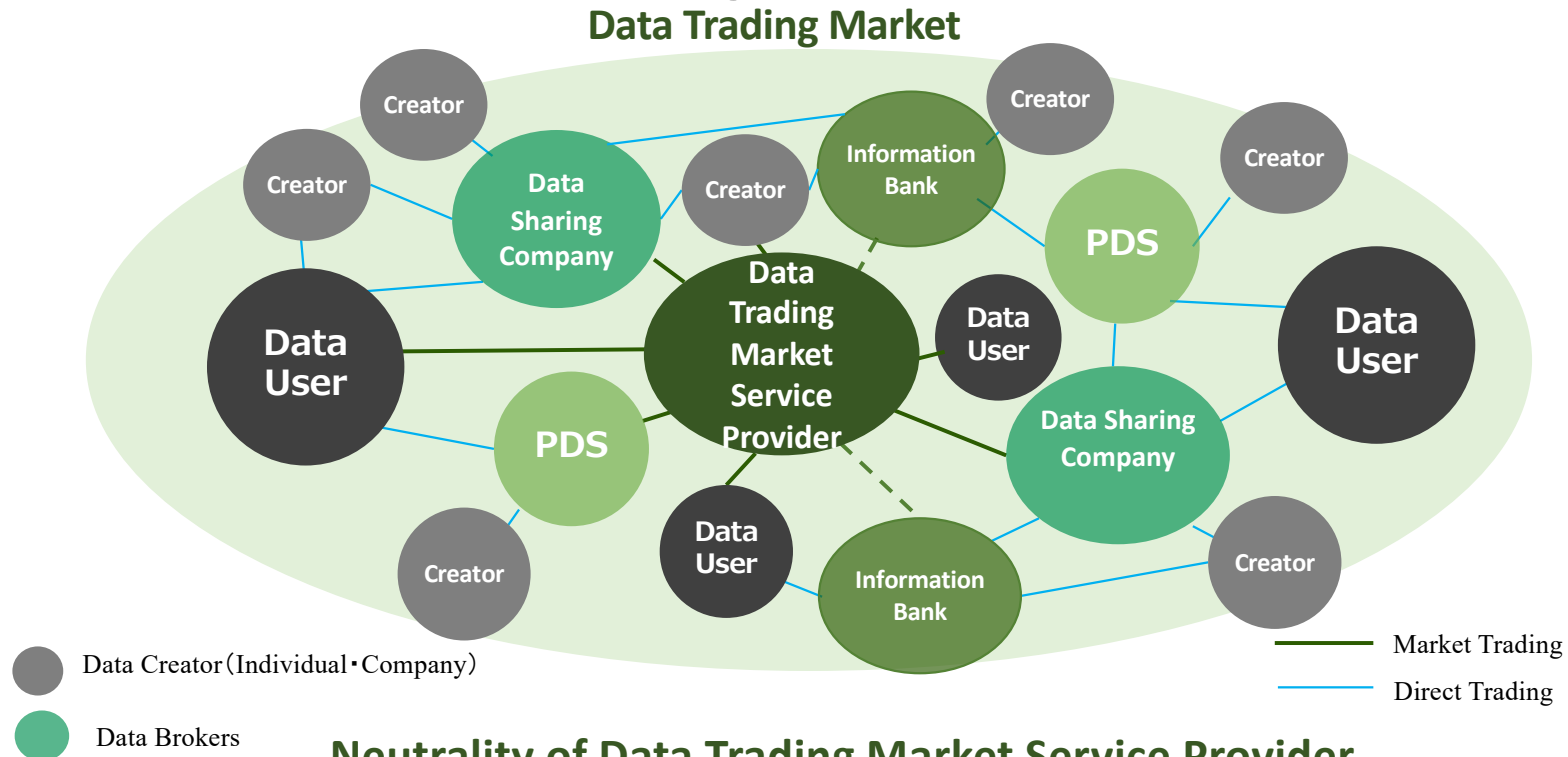

Neutrality of Data Trading Market Service Provider

Neutral for Data price formation Monitoring to avoid fraudulent transactions Protection for data traders

Data trading market service providers are required to be neutral so as not to conduct transactions that are advantageous to themselves in the market they operate, and to ensure their external neutrality. They are required not to participate for any trading for themselves. In addition, neutrality is required to guarantee fairness for individual market participants.

Hiroshi Mano (Data Society Alliance)

Standardization activities in DTA

- Operator certification of Data Trading Market Service Provider / **Published 2018/09 in Japan**
- Standard of **Data Catalog format**
- Standard of **Vocabulary** used in data catalog
 - Help to find appropriately data in trading
 - Help to compare and choice desired data in trading
- Data Quality
 - Standard **evaluation method** help to fairness of data trading

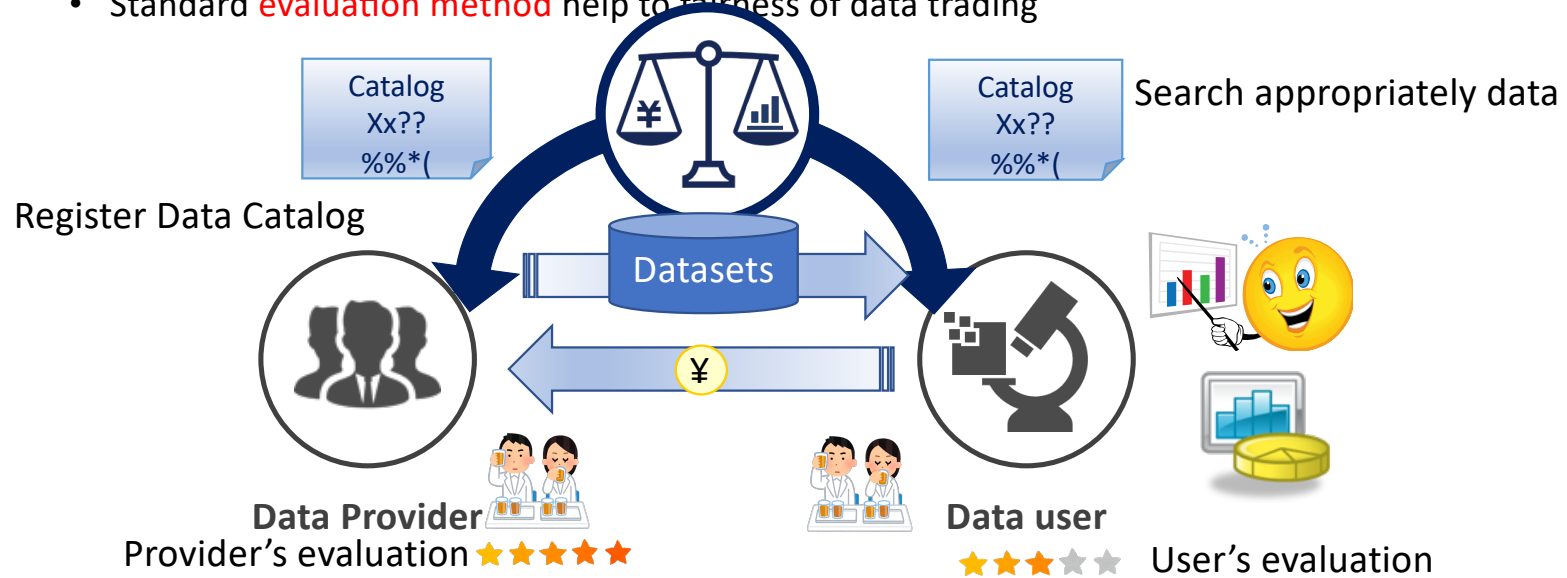

IEEE P3800 の事例

2020 Jun PAR 承認後

IEEE DTSWG(P3800)進捗状況

- IEEE DTSWG(P3800)進捗状況。
- 規格開発ライフサイクルにおける位置づけ

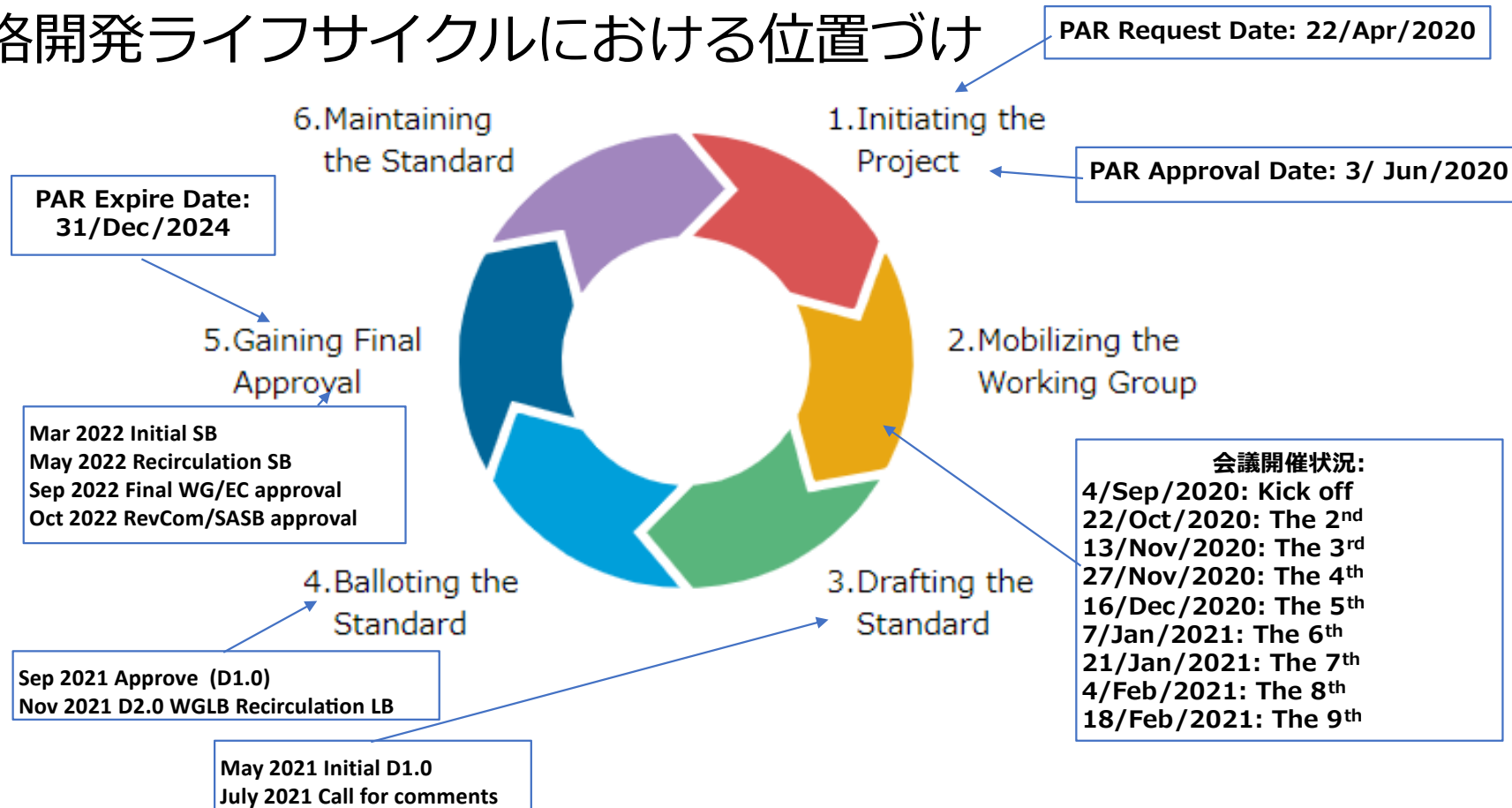

P3800会合参加状況

• IEEE P3800会議 各回の参加人数

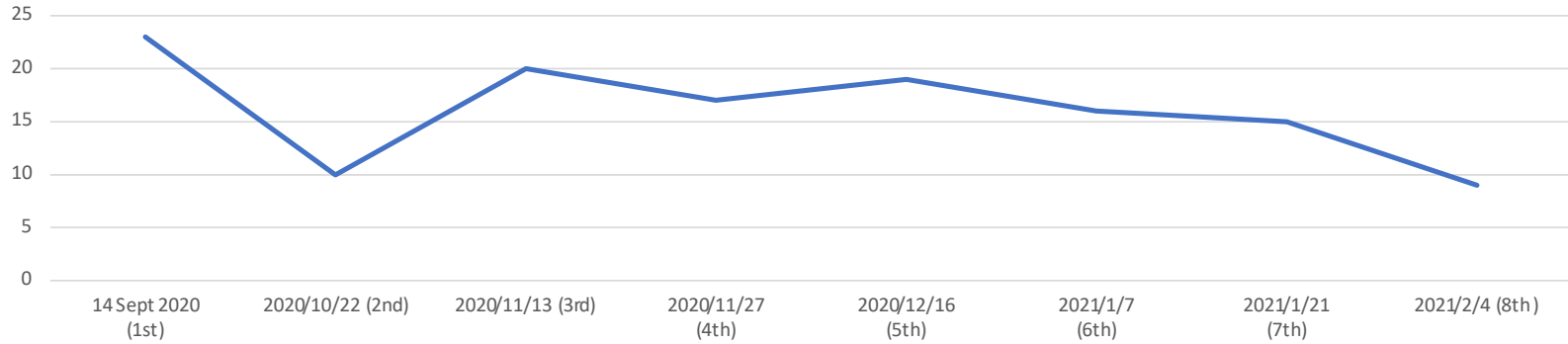

参加者の組織と累積参加回数

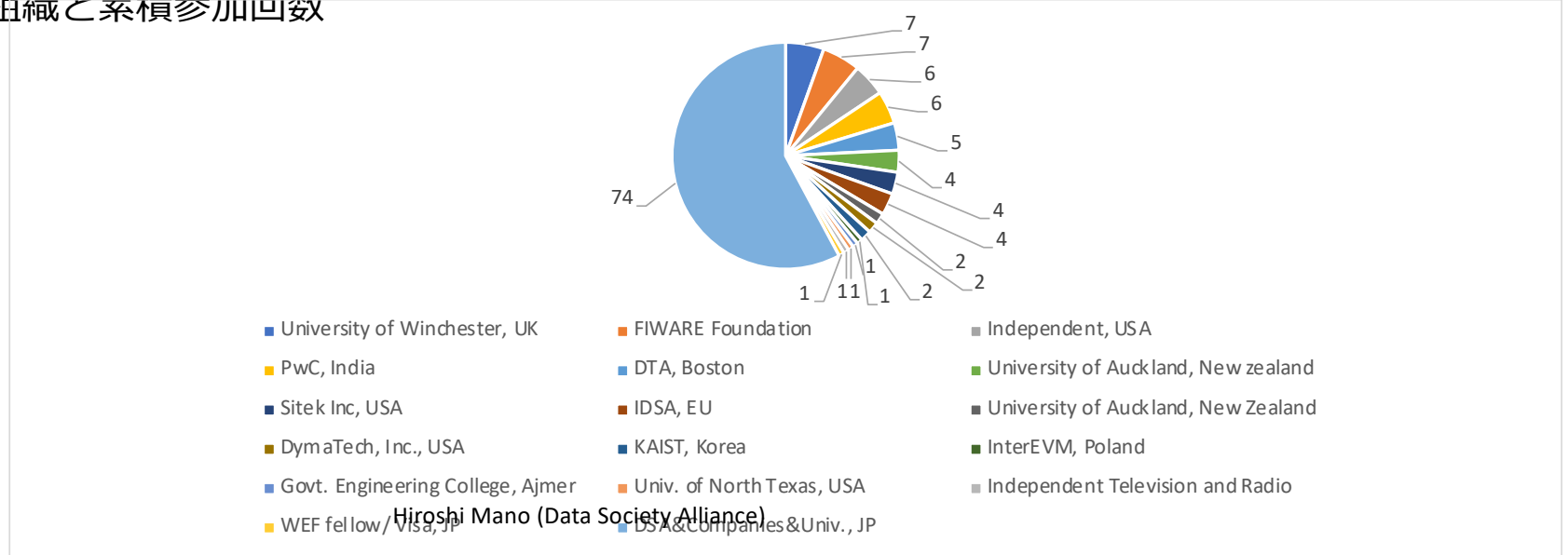



IEEE P3800 Society & Standard Committee

- 3.1 Working Group: Data Trading System Working Group(CES/DFESC/DTSWG)
 - 3.1.1 Contact Information for Working Group Chair:
 - Name: Hiroshi Mano
- 3.2 Society and Committee:
 - IEEE Consumer Electronics Society/Digital Finance and Economy Standards Committee(CES/DFESC)



Type of Ballot & Timeline

- **4.1 Type of Ballot: Individual**
- 4.2 Expected Date of submission of draft to the IEEE SA for Initial Standards Committee Ballot: Mar 2022**
- 4.3 Projected Completion Date for Submittal to RevCom: Oct 2022**



5.2 Scope of proposed standard:

- This standard establishes a system designed to trade data through domain-independent and principled marketplaces operating under a unified architecture. It defines terminology, a reference model, and the roles and functions of data providers, data users, and data marketplaces. The standard provides an overview of the data trading system using its reference model.
- この標準規格は、統一されたアーキテクチャの下で動作する、ドメインに依存しない原則的なマーケットプレイスを通じてデータを取引するように設計されたシステムを確立するものである。用語、参照モデル、データ提供者、データ利用者、データマーケットプレイスの役割と機能を定義する。本標準規格は、参照モデルを使用したデータ取引システムの概要を提供する。



5.4 Purpose:

- This standard provides the foundation for a data-trading system that allows multilateral exchanges of data.
- この規格は、多機関間でのデータ交換を可能にするデータ取引システムの基礎を提供します。



5.5 Need for the Project:

- There is currently no known standard for systems that allow trading data across different sectors or industry domains. A standard is needed to enable such a domain-independent marketplace system.
- Today's data-driven businesses generate and utilize a wide range of data for each business's purpose in a closed, proprietary data collection or distribution system, or acquire through bilateral trading. However, businesses often lack some data needed to realize their ultimate goals while under-utilizing some other data. Therefore, the value of existing data may significantly increase if the data could be bought or sold in a fair marketplace. Adoption of a data-trading system simplifies multilateral data trading and enhances interoperability.
- 現在のところ、異なるセクターや産業ドメインをまたいだデータ取引を可能にするシステムの標準は知られていません。このようなドメインに依存しないマーケットプレイスシステムを可能にするための標準が必要とされている。
- 今日のデータ駆動型ビジネスは、クローズドで独自のデータ収集・流通システム、あるいは相対取引により、それぞれのビジネスの目的に応じた多種多様なデータを生成・活用している。しかし、ビジネスの最終的な目的を実現するために必要なデータの一部が不足している一方で、他のデータの一部が十分に活用されていないことが多い。そのため、公正な市場でデータを売買することができれば、既存のデータの価値が大幅に上がる可能性があります。データ取引システムの採用は、機関間でのデータ取引を簡素化し、相互運用性を高める。



5.6 Stakeholders for the Standard:

- Users of third-party data sources, data producers and sellers, IoT device manufacturers, mobile app developers, consumer data privacy advocates, and government agencies.
- サードパーティのデータのユーザー、データの生産者と販売者、IoTデバイスメーカー、モバイルアプリ開発者、消費者データのプライバシー擁護者、政府機関。

Proposed Reference Model

- The following slides describe the overview of the proposed reference model.
- **This is presented by myself and are not official working group approved.**
- These slides may help your understanding of what we are discussing in IEEE P3800.

Structure and basic stakeholders

- **Data-provider**
 - A data-provider is a generic term for an organization that provides data to others via the DTS for compensation.
- **Data-user**
 - A data-user is an organization that receives data from others via DTS and provides compensation according to the data value. The data value is not limited to paid but also includes free.
 - Note: According to IDS' reference architecture, there are two definitions of "Data consumer" and "Data user." From a DTS point of view, P3800 defines both "Data consumer" and "Data user" as "Data-user."
- **DTS (Data Trading System)**
 - DTS is a system that provides intermediary and settlement services between data-providers and data-users and is provided by an organization (DTS operator) that is independent of data-provider and data-user.
 - DTS shall have a structure, either centralized or decentralized systems.
- **TTP (Third Trust Party)**
 - A TTP is a certification authority that proves mutual authentication among data-providers, DTS operators, and data-users.
 - TTP is independent of the data-provider, DTS operator, and data-user.
 - TTP shall have a structure, either centralized or decentralized systems.

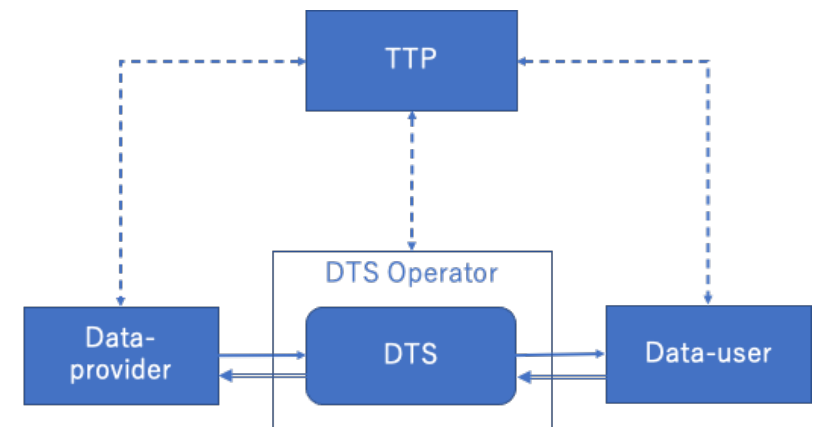

←---→ Trust Information

→ Data object

← Benefit

Hiroshi Mano (Data Society Alliance)

This is presented by myself and are not official working group approved.

Objects to be handled by DTS

- **Dataset**
 - The dataset is the data itself that is provided from the data-provider to the data-user via the DTS
- **Trading term**
 - The trading term is terms of use, compensation, etc., for a data set agreed upon between the data-provider and the data-user.
 - Trading terms include information that uniquely identifies the dataset to which the transaction terms apply.
 - The trading term applies to each data transaction.
- **Data catalog**
 - The data catalog outlines the data set and the terms of the transaction. A data catalog includes ancillary information, such as regulatory information that restricts the dataset's use and dataset provision.
 - Data-providers who wish to trade data provide the data catalog to the DTS.
 - The DTS discloses the data catalog to the data-user.
 - Data catalog does not depend on a particular data transaction but depends on each dataset.
 - For the implementation of such a catalog, the W3C DCAT has standardized the vocabulary and meta tags.
- **Benefit**
 - The benefit is the consideration given by the data-user to the data-provider via the DTS based on the trading terms.
 - The benefit can be a currency with a convertible economic value or a voucher that can be used for a specific service.
 - There are also trading that does not involve the provision of benefit based on the agreement of the parties.
- **Trust Information**
 - Trust information is provided by a TTP for mutual authentication of data-providers, DTS operators, and data-users.
 - Authentication information should consist of the public key for PKI, private key, electric certificate, etc.

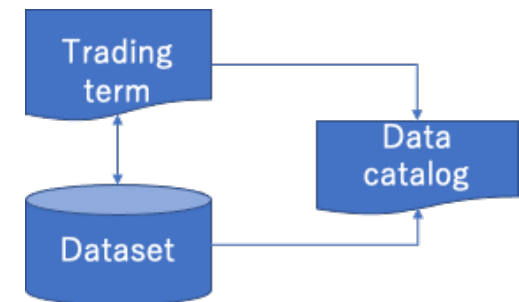

This is presented by myself and are not official working group approved.

Hiroshi Momo (Data Society Alliance)

Required function(s)

Advertisement of data catalog

- DTS provides a mechanism to advertise the data catalog given by data-providers.

Discovery of data catalog

- DTS provides a mechanism to discover the data catalog given by data-providers.

Support consensus making of data trading

- DTS provides a supporting mechanism to improve the mutual consensus of data trading between data-provider and data-user.

Settlement of data trading

- DTS provides a mechanism of settlement of data trading such as billing, collections.

Clearinghouse

- DTS provides an appropriate clearinghouse function as an intermediary to prevent illegal data transactions.

Hiroshi Mano (Data Society Alliance)

This is presented by myself and are not official working group approved.

Required Policy / Rules

Neutrality

- DTS or the DTS Operator shall not interfere with particular data trading terms.
- The data-provider and data-user make the price and content of trading datasets by themselves without any bias of DTS/DTS operators.

Fairness

- The DTS or the DTS Operator shall provide equal opportunity for data trading to all of data-providers and data-users.

Compliance

- DTS or the DTS operator shall eliminate the illegality of data trading conducted via DTS.

Authenticity Guarantee

- DTS or the DTS Operator warrants that the dataset has been correctly traded under the trading term.

This is presented by myself and are not official working group approved.

Hiroshi Mano (Data Society Alliance)

Spec Frame Documentの 提案

2021/3/1

- Normative references
- Definitions, acronyms, and abbreviations
 - Definitions
 - Definitions specific to IEEE Std 3800
 - Abbreviations sand acronyms
- General description
 - Overview of the services
- Reference model
 - System structure
- Stakeholders
 - Data-Provider
 - Data-user
 - TTP(Third Trust Party)
- Object
 - Dataset
 - Data catalog
 - Trading term
 - Benefit
- Functional requirement
- Nonfunctional requirement
- Data process flow
- Recommend API
- Annex
Hiroshi Mano (Data Society Alliance)

今後の予定と取り組みの戦略

• Timeline

- | | | |
|-------------|------------------|----------------------|
| • Sep 2020 | working group | First meeting as a |
| • May 2021 | | Initial D1.0 |
| • July 2021 | | Call for comments |
| • Sep 2021 | | Approve (D1.0) |
| • Nov 2021 | Recirculation LB | D2.0 WGLB |
| • T.B.D. | | Form SB Pool |
| • T.B.D. | | MEC/MDR done |
| • Mar 2022 | | Initial SB |
| • May 2022 | | Recirculation SB |
| • Sep 2022 | | Final WG/EC approval |
| • Oct 2022 | | Revcom/SASB approval |

- タイムラインを意識し、SFDを日本側で記述し発表することで、全体の流れを作る。
- テクニカルエディタを選出
 - テクニカルエディタを決定する時期であり、その人選について戦略的に候補を模索中である。
- 人材育成
 - インターン生1名に、IEEE-SAのe-learning コースの受講をしてもらい、研修を終了。



他の標準化活動との連携

ISO/IWA39 2021/02/10,11

- “Gap analysis for standardization on sustainable and human-centered societies enabled with cyber physical systems”
- ISO/IWA39にて、IEEE P3800 の概要を説明した。
- 今後、リエゾン締結についての議論も踏まえて協議を継続
- 開催後、2名がP3800への参加申し込みがあった。
- 類似標準として、Indian Standard IS18003 “Unified Data Exchange”の紹介を受け、協業のあり方の検討を開始した。

WEF DCPI 2021/02/09

- インドでの事例発表。概念はあるが、データの権利の明確化や価格形成にむけた具体的な取り組みについては、明確になっていない。

GAIA-X & RRI

- GAIA-X,RRI,と2021年2月24日に連携推進をすることを協議。

To Join P3800 WG

- [WG HP](#)
 - <https://sagroups.ieee.org/3800/>
- [http://sagroups.ieee.org/3800/wp-content/uploads/sites/196/2020/12/CEM_P3800-preprint.pso .pdf](http://sagroups.ieee.org/3800/wp-content/uploads/sites/196/2020/12/CEM_P3800-preprint.pso.pdf)
- Send email to Chair h.mano@data-trading.org to join P3800 workspace (iMeetCentral)

Hiroshi Mano (Data Society Alliance)

Data-trading standard's potential to uncover the value of data reserve

Ryuji Suzuki, a member of IEEE P3800 Data-Trading System Working Group
Hiroshi Mano, the chair of IEEE P3800 Data-Trading System Working Group

19 December 2020

©2020 IEEE. Personal use of this material is permitted. Permission from IEEE must be obtained for all other uses, including reprinting/republishing this material for advertising or promotional purposes, collecting new collected works for resale or redistribution to servers or lists, or reuse of any copyrighted component of this work in other works.

People say data is the new dominant raw material replacing oil, to emphasize its economic significance. Many companies have unused data, and collectively, there is a massive amount of unutilized or residual data, which could enable new business models. On the other hand, not all businesses have a complete set of data to implement their ultimate goals. Therefore, the data's values could increase if freely shared or traded, especially because the data can be used multiple times for various purposes, often without decreasing the data's value. However, data trading is not widely accessible at this point, and we are underutilizing the existing data reserve.

Data are currently traded through bilateral arrangements or domain-specific network. For example, companies dealing with consumer finance often buy data related to individuals and real estate properties. The data are actively generated and provided, almost like a service. In other cases, such as in energy distribution, data is traded through networks specific to their industry. When the transactions are confined to a particular sector, it is relatively likely for the sellers and buyers to recognize each other. However, the industry-specific approaches are too narrowly scoped to extract the full value of general data.

IEEE P3800 working group, sponsored by IEEE Consumer Technology Society Digital Finance and Economy Standards Committee, aims to develop a standard for a general-purpose, open mechanism to trade a wide variety of data. Data providers can register the data before finding a buyer. The marketplace should be equipped with a search function so that the buyers can search through the catalog of data being offered to see what they need. The marketplace also should have a data-agnostic way of evaluating the quality of the data. Thus, a data marketplace becomes the central institution enabling multilateral transactions.

In this trading structure, each marketplace is also an independent and neutral entity to implement policies to comply with various privacy laws and the essence of the fair information practice principles. The privacy laws are a rapidly evolving area, mostly concerned about limiting mega-corporations and data brokers' activities, but they mostly forget many other forms of data uses. We'll need to debate fair regulations beneficial to the public and newer, innovative businesses operating on different profit models from mega-platforms. The P3800 standard should incorporate the necessary policies and enforcement mechanisms.

The idea of trading data is not new, but we need a fresh solution for the general-purpose data marketplace's challenges. The trust issue is central, and it needs to be established broadly, well beyond that of the transaction itself, because the data providers need to trust that the data won't be abused. The buyer needs to trust that the data is authentic and of good quality. We will have to find a solution by combining



Summary of Data Trading System

- If we compare the digital society to the human body, data is the blood.
- And **data distribution** is the **blood flow**.
- As you may know, the bloodstream consists of arteries and veins that make up the circulatory system.
- Similarly, data distribution is not a one-way collection of data and should make a circulation system enabling a digital society.
- **DTS** will realize a **data circulation** system.